

	Kg.
	cm.



PC & Macbook  
<https://get.adobe.com/uk/reader/>

Tablet & iPad  
<https://www.adobe.com/acrobat/mobile.html>

ENG 

DE 

FR 

DK 

**FAUTEUIL ROULANT SUR MESURE**



11100000100? 4.800 €		

619000001009		
619000001109		
619000001209		
619000001309		
619000001409		
619000001509		
619000001609		
619000001709		
619000001809		
619000001909		
619000002009		
619000002109		
619000002509		
619000002609		
619000002809		
619000003309		
619000003409		
619000003509		
619000003609		
619000003009 <b>750 €</b>		
000000001102 <b>0 €</b>		

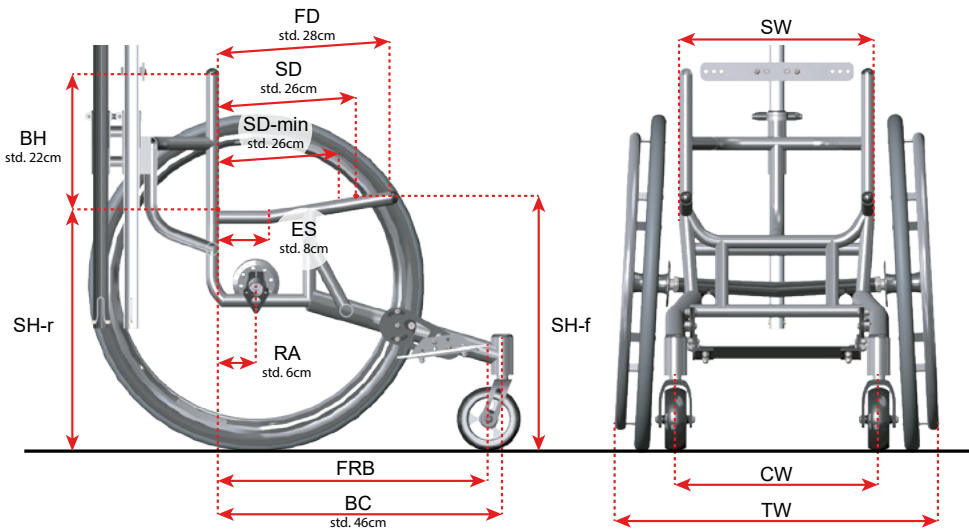

	!		SW: _____ cm
	!		FD: _____ cm
	!		SD: _____ cm
	!		SD-min: _____ cm
	!		SH-r _____ cm
	!		SH-f: _____ cm
	!		C: _____ °
812199000010 58 € 812199000011 58 €			BH: _____ cm
	!		BH-d: _____ cm
			BH-max: _____ cm
			BH-min: _____ cm
	!		RA: _____ cm
610000001009 610000??0001 255 €			ES: _____ cm
			BC: _____ cm
			CW: _____ cm
			TW: _____ cm

--	--

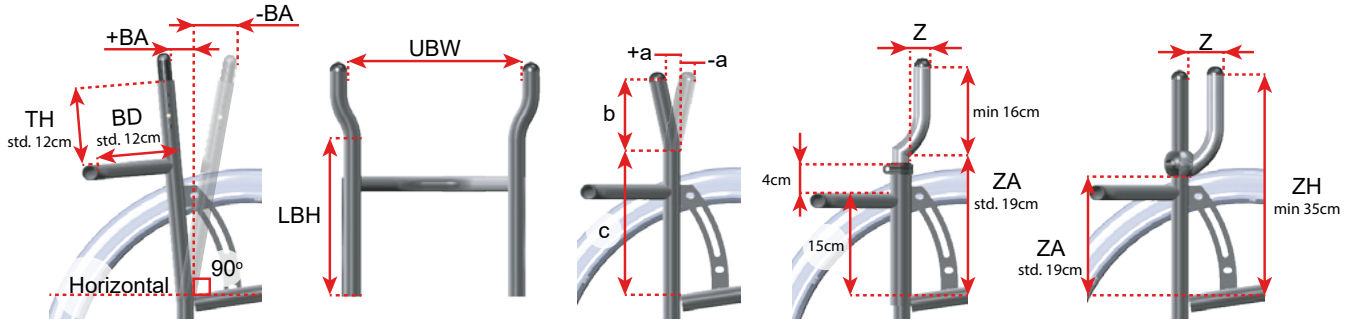

813100050???			
<b>0 €</b>			
813100051???			<b>BA:</b> _____ ±cm
<b>366 €</b>			
813100051???			
	<b>!</b>		<b>BD:</b> _____ cm
			<b>TH:</b> _____ cm

8122002001??			
<b>560 €</b>			
8122002001??			_____ cm
<b>723 €</b>			
82501000????			
<b>560 €</b>	<b>!</b>		<b>ZA:</b> _____ cm
8122002001??			<b>Z:</b> _____ cm
<b>930 €</b>			<b>ZH:</b> _____ cm
8122002001??			
<b>930 €</b>			

8861101013??			
<b>325 €</b>			
8861101013??			
<b>325 €</b>			
886110102001			<b>AF:</b> _____ cm
<b>325 €</b>			<b>AW:</b> _____ cm



--	--

Subject to Technical Modifications and Printing Errors / Technische Änderungen und Druckfehler vorbehalten  
 Forbehold for tekniske ændringer og trykfejl  
 Fill in and send to Wolturnus - Ausfüllen und an Wolturnus senden - Udfyld og send til Wolturnus  
 © Wolturnus A/S W5jr. Winter 2024, v4.0

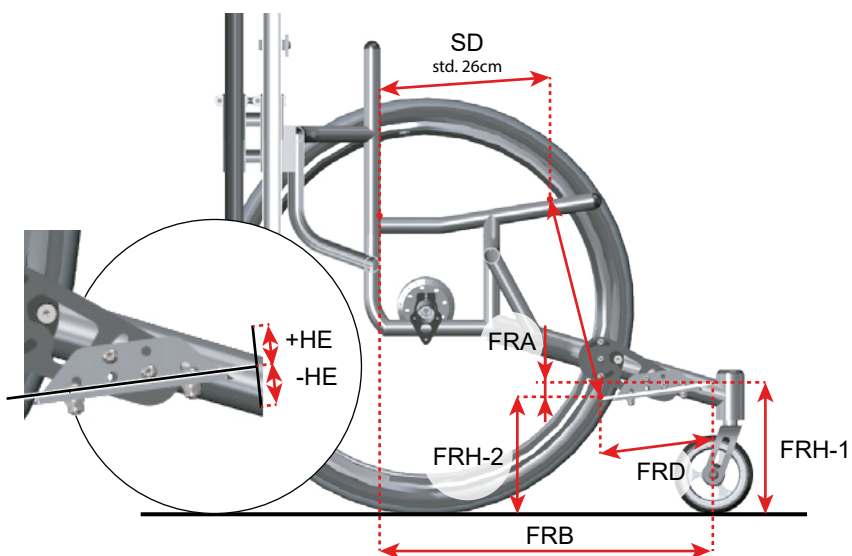



		<b>VSL/USL:</b> _____ cm
		<b>FRH-1:</b> _____ cm
		<b>FRH-2:</b> _____ cm
		-1,5    -3 +1,5    +3
823028991500 <b>0 €</b>		<b>FRB:</b> _____ cm
821920869000 <b>498 €</b>		<b>FRD:</b> _____ cm
		<b>FRA:</b> _____ cm
835099210001 <b>68 €</b>	!	
829999012001 <b>37 €</b>		<b>HE:</b> _____ ±cm



--	--

Fill in and send to Wolturnus - Ausfüllen und an Wolturnus senden - Udfyld og send til Wolturnus



Subject to Technical Modifications and Printing Errors / Technische Änderungen und Druckfehler vorbehalten  
Forbehold for tekniske ændringer og trykfejl

			1+    2+    3+    4+    5+
761000000010 <b>245 €</b>			
710000000001 <b>0 €</b> 710099990010 <b>440 €</b> 710099990012 <b>470 €</b> 710099990013 <b>470 €</b> 710099990011 <b>470 €</b>			
710099990000 <b>0 €</b> 710099990003 <b>185 €</b> 710099990004 <b>185 €</b> 710099990002 <b>185 €</b> 710099990001 <b>0 €</b>			
750000009000 <b>265 €</b> - <b>0 €</b> 750000000005 <b>68 €</b>	!		!  _____ cm / _____ cm  5cm Std.                      7cm  Medium Std.                      Hard

885110101001 <b>0 €</b>			
885110101003 <b>0 €</b>			
885110111001 <b>199 €</b>			
885110122002 <b>60 €</b> 88511012200? <b>120 €</b>			
885110301009 <b>702 €</b>  885110301009 <b>702 €</b>			
885110101101 <b>199 €</b>			
885110111101 <b>199 €</b>			
951519204000 <b>90 €</b> <b>180 €</b>			
885110201209 <b>225 €</b>			
885110301015 <b>867 €</b>			

--	--



				
881000100003 <b>0 €</b>				
881000600003 <b>0 €</b>				
881000?0000 <b>340 €</b>				
88100010000? <b>0 €</b>				
88100020000? <b>725 €</b>				
88100030000? <b>800 €</b>				



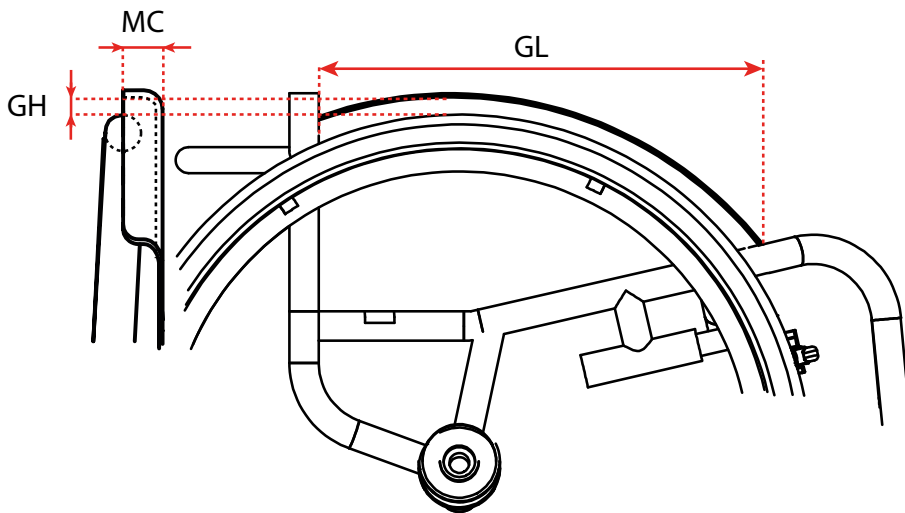

681000010002 <b>70 €</b>			
7670000000?? <b>170 €</b>			

		<b>GH:</b>	_____ cm
		<b>GL:</b>	_____ cm
		<b>MC:</b>	_____ cm

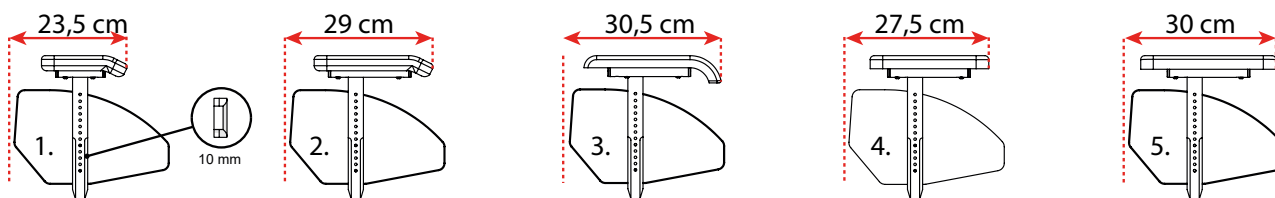

--	--



951000080119 <b>550 €</b>			AB = 23,5 cm AL = 16 cm	
881001000003 <b>550 €</b>			AB = 29 cm AL = 23,5 cm	
881001100003 <b>550 €</b>			AB = 30,5 cm AL = 27,5 cm	
881001200003 <b>550 €</b>			AB = 27,5 cm AL = 23,5 cm	
881001300003 <b>550 €</b>			AB = 30 cm AL = 27 cm	
681000010007 <b>95 €</b>				

	!		AS: _____ cm
--	---	--	--------------

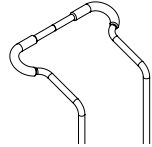
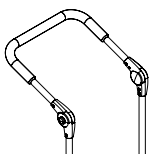
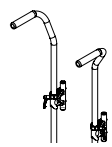

885200031005 <b>382 €</b>				
88520003100? <b>650 €</b>				
88520003100? <b>650 €</b>				
88520003100? <b>650 €</b>				
88520003100? <b>650 €</b>				
885200011501 <b>524 €</b>			5 cm 10 cm 15 cm	
	!			_____ cm

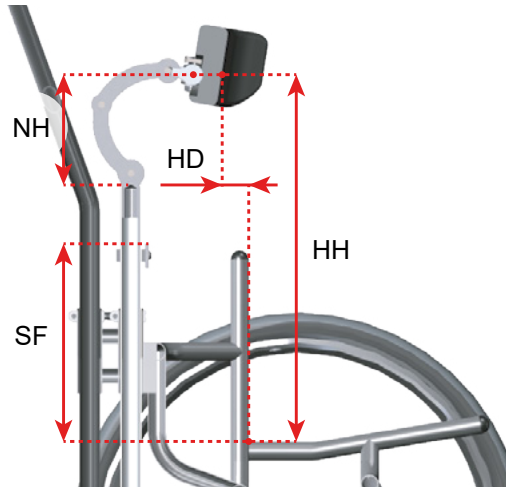
--	--	--	--	--



Fill in and send to Wolturnus - Ausfüllen und an Wolturnus senden - Udfyld og send til Wolturnus

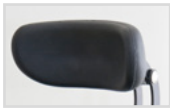







Subject to Technical Modifications and Printing Errors / Technische Änderungen und Druckfehler vorbehalten  
Forbehold for tekniske ændringer og trykfejl

884100013001 <b>240 €</b>					
884100014001 <b>345 €</b>					
951000080130 <b>90 €</b>				NH: _____ cm	
951000080131 <b>110 €</b>					
951000080141 <b>110 €</b>				HH: _____ cm	
951000080142 <b>110 €</b>					
840000100831 <b>180 €</b>					
840000100832 <b>210 €</b>				HD: _____ cm	
884100250100 <b>190 €</b>				SF: _____ cm	

887000200001 <b>498 €</b>				
------------------------------	--	--	--	--

7600000100?? <b>68 €</b> <b>63 €</b>					
--	--	--	--	--	---

--	--



860010201251	0 €	Std.	LED
860010201000	0 €	 	
860010201001	0 €		
860010200801	0 €		
860010101401	0 €	40mm	
860010101253	0 €		
860010101002	0 €		
860010200910	178 €		
860010200900	178 €		
8600101015??	450 €		
8600101015??	450 €		
86001010201?	0 €		
	0 €		
	0 €		
8600101020??	0 €		
	0 €		
860020000000	+52 €		
86001020150?	325 €		
	325 €		
860010201???	325 €		
	325 €		
	325 €		
860010201???	325 €		
	325 €		
	325 €		
860010201???	377 €		
	377 €		
	377 €		
	377 €		
860010201???	377 €		
	377 €		
	377 €		
	377 €		
	0 €		
	160 €		
	160 €		
	160 €		
885201001001	600 €		
862400001009	314 €		



--	--	--	--	--	--

	20"	22"	24"	
85102??01009				0 €
85102?10100?	-	-		0 €
8510??101002	-			257 €
851124201009	-	-		471 €

853728111019				817 €		!
853728111020	-					

8537281110??	-			1.309 €		!
--------------	---	--	--	---------	--	---

	20"	22"	24"		
85352?101008				895 €	
85352?101208				895 €	
85352?101508	-			895 €	
85352?101308				895 €	
85352?102108				895 €	
85352?101009				695 €	
85352?101209				695 €	
85352?101509				695 €	
85352?101309				695 €	
85352?101?09				695 €	

85352?101608				950 €	
85352?101408				950 €	
85352?101808	-	-		950 €	
85352?101708				950 €	
85362?241008				950 €	
85362?241208				950 €	
85362?241508	-	-		950 €	
85362?241308				950 €	
85362?181008				950 €	
85362?181208				950 €	
85362?181508	-	-		950 €	
85362?181308				950 €	

--	--

Fill in and send to Wolturnus - Ausfüllen und an Wolturnus senden - Udfyld og send til Wolturnus

Subject to Technical Modifications and Printing Errors / Technische Änderungen und Druckfehler vorbehalten  
Forbehold for tekniske ændringer og trykfejl

© Wolturnus A/S W5jr. Winter 2024, v4.0

	20"	22"	24"		
96622?010001				<b>0 €</b>	
96622?01000?	-			<b>68 €</b>	
96622?010009				<b>146 €</b>	
96622?010021	-	-		<b>146 €</b>	
966224010013	-	-		<b>68 €</b>	
96622?011008	-	-		<b>68 €</b>	
966224010007	-	-		<b>68 €</b>	

85512?10200?				<b>0 €</b>	
85512?102008				<b>194 €</b>	
85502?103009	-	-		<b>178 €</b>	
85552?000009				<b>503 €</b>	
8554202?0601				<b>315 €</b>	

85712?102009				<b>178 €</b>	
--------------	--	--	--	--------------	--

85712?102117 <b>325 €</b>					
85712?102109 <b>325 €</b>					
85712?102115 <b>325 €</b>					
85712?102116 <b>325 €</b>					
85712?102111 <b>325 €</b>					
85712?102114 <b>325 €</b>					
85712?102110 <b>325 €</b>					
85712?102112 <b>325 €</b>					
85712?102113 <b>325 €</b>					
85712?102118 <b>325 €</b>					

--	--	--	--	--	--

--	--	--	--	--	--

000000001104 <b>100 €</b>		EN ISO 14971
P.4		
P.5		
P.6		
P.7		
P.8		
P.9		
P.10		
P.11		
P.12		
P.13		
P.14		

