

Tailor-made Wheelchair

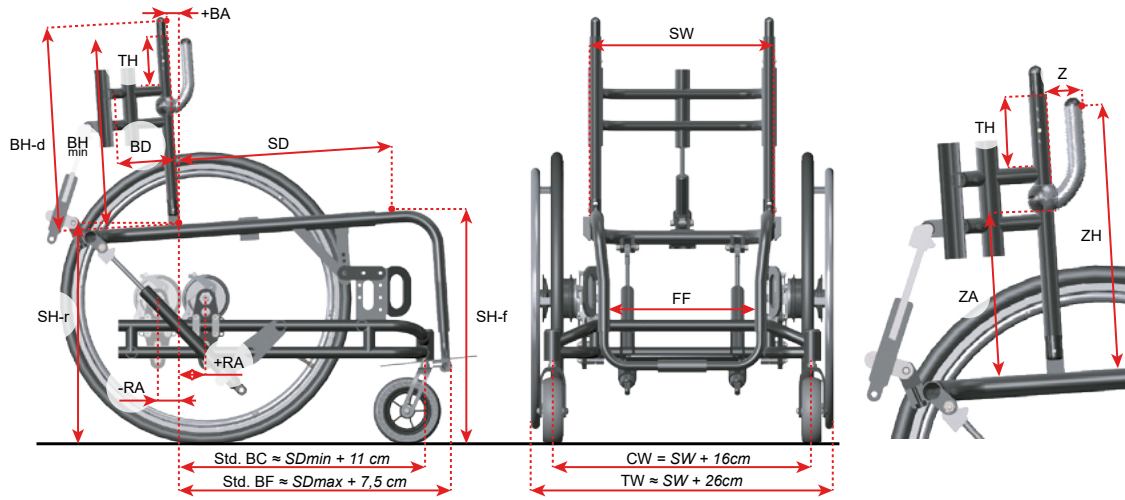

231000001000 6.000 €		
231000001010 6.000 €		
231000001020 6.000 €		
231000001030 6.000 €		
231000001040 6.000 €		
231000001050 6.000 €		
231000001060 6.250 €		
231000001070 5.300 €		
500000000006		
500000000006		

619000002109		
619000002509		
619000002609		
619000002809		
619000003309		
619000003409		
619000003509		
619000003609		
619000003009 700 €		
000000001102 400 €		



	!		SW: _____ cm
	!		SD: _____ cm
	!		SH-r _____ cm
	!		SH-f: _____ cm
	!		C: _____ °
	!		BH-d: _____ cm
	!		BH-max: _____ cm
	!		BH-min: _____ cm
887000100010 0 €	!		BA: _____ cm
811100000000 565 €			
811100002005 240 €			
611000??0009 0 €	!		RA: _____ cm
691100000090 530 €			
61000001009 0 €	!		ES: _____ cm
610000??0001 245 €			
			TW: _____ cm
			FF: _____ cm

Fill in and send to Wolturnus - Ausfüllen und an Wolturnus senden - Udfyld og send til Wolturnus

980001500150 0 €		
88700014000? 3000 € 4000 €		

8122002001?? 690 €				
8122002001?? 690 €				
	!			ZH: _____ cm
	!			ZA: _____ cm
8122002001?? 890 €				Z: _____ cm ZH: _____ cm

				VSL/USL: _____ cm
	!	SW 26 cm = VSL 28 cm +/- 3 cm	SW 30 cm = VSL 32 cm +/- 3 cm	SW 34 cm = VSL 36 cm +/- 3 cm
		SW 38 cm = VSL 38 cm +/- 3 cm	SW 42 cm = VSL 40 cm +/- 3 cm	SW 45 cm = VSL 40 cm +/- 3 cm
				-1,5 -3 +1,5 +3



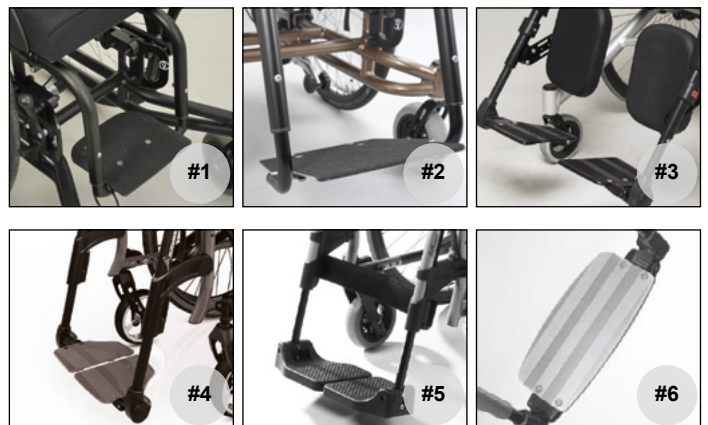
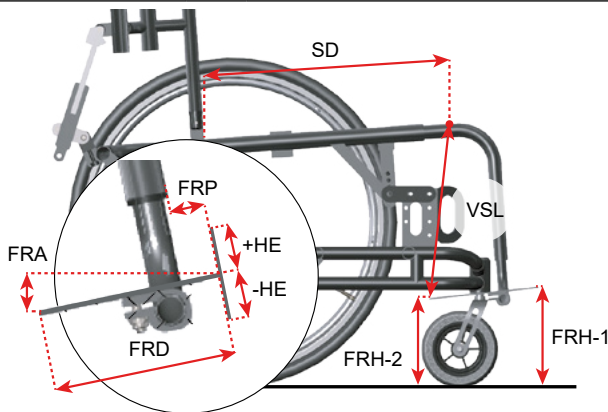



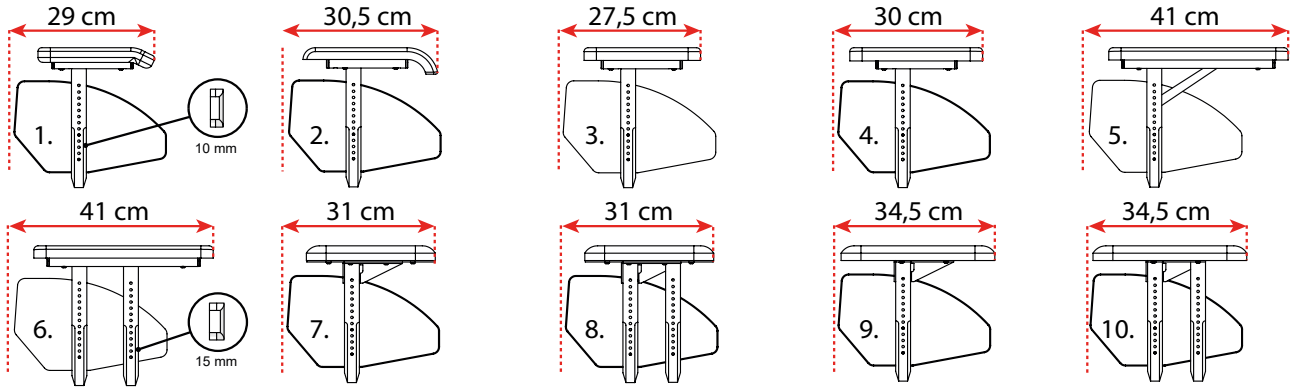

950599992?50 0 €				FRP: _____ cm
8299990?000? 300 € 365 € 500 €				FRD: _____ cm FRP: _____ cm +/- HE: _____ cm
8???999?1?00? 65 € 263 €				
835050001001 935 €				! FRA: _____ cm
840010000170 660 €				
840010000180 280 €				
82999901001? 440 €				

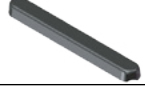

--	--	--

© Wolturnus A/S A-Run Winter 2023 v3.0



881001000003 525 €			AB = 29 cm AL = 23,5 cm	
881001100003 540 €			AB = 30,5 cm AL = 27,5 cm	
881001200003 525 €			AB = 27,5 cm AL = 23,5 cm	
881001300003 550 €			AB = 30 cm AL = 27 cm	
881001?00003 790 € 930 €			AB = 41 cm AL = 37 cm	
881001?00003 850 € 975 €			AB = 31 cm AL = 26 cm	
881001?00003 850 € 975 €			AB = 34,5 cm AL = 31 cm	
681000010004 165 €				
681000010007 90 €				
	!		AS: _____ cm	

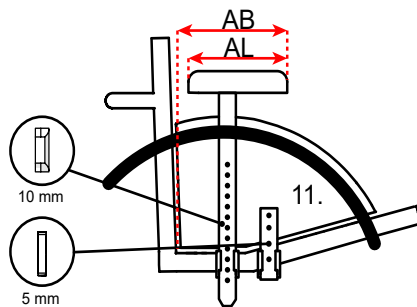





		1+ 2+ 3+ 4+ 5+				
761000000010						
235 €						

710000000001				
0 €				
710099990010				
420 €				
710099990012				
450 €				
710099990013				
450 €				
710099990011				
450 €				

710099990001				
0 €				
710099990003				
175 €				
710099990004				
175 €				
710099990002				
175 €				
710099990000				
0 €				

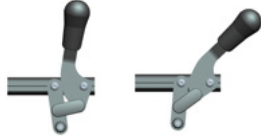
750000009000				!	
255 €				_____ cm / _____ cm	
-					
0 €					
750000000005	!			5cm Std.	7cm
65 €				Medium Std.	Hard

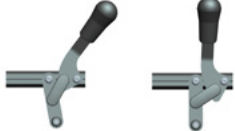
950599993?50			
0 €			
950599990?50			
0 €			

885110101001 0 €			
885110101003 0 €			
885110111001 190 €			
885110122002 60 € 88511012200? 120 €			

8400002072XX 430 €			
------------------------------	--	--	--

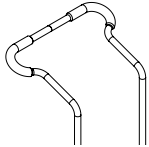
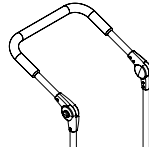
88520003100? 621 €			
88520003100? 621 €			
88520003100? 621 €			
88520003100? 621 €			
	!		_____ cm

884140000500 220 €		
884142531009 440 €		
884142301009 500 €		

8401????0090 395 €		
870019000004 946 €		

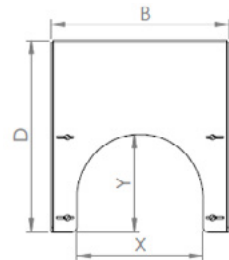
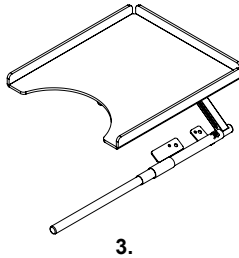
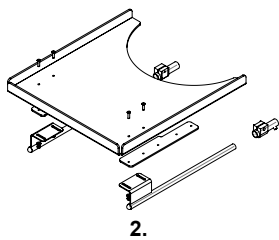
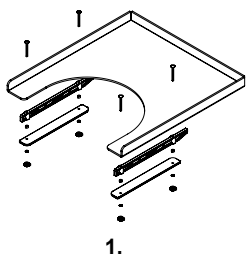

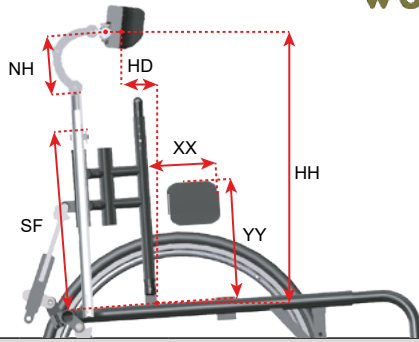

--	--



Fill in and send to Wolturnus - Ausfüllen und an Wolturnus senden - Udfyld og send til Wolturnus

Subject to Technical Modifications and Printing Errors / Technische Änderungen und Druckfehler vorbehalten
Forbehold for tekniske ændringer og trykfejl

© Wolturnus A/S A-Run Winter 2023 v3.0

884100017001? 230 € 330 €					
951000080130 85 €				NH: _____ cm	
951000080131 105 €					
951000080141 105 €				HH: _____ cm	
951000080142 105 €					
84000010082? 350 € 350 €				HD: _____ cm	
84000010083? 170 € 200 € 200 €					
84000010083? 225 € 225 € 225 €					
84000010083? 500 € 500 €					
884100250100 180 €					SF: _____ cm

884010101001 200 € 200 €					
884010101010 120 €				XX: _____ cm	
884010101011 125 €					YY: _____ cm
884010101012 130 €					
812200200060 95 €					

887000200011 2.300 €					
--------------------------------	--	--	--	--	--

771100000747 100 €					
------------------------------	--	--	--	--	--

--	--	--	--	--	--

	4"	5"	6"	
860010101401 0 €	-	-		
860010101253 0 €	-		-	
8600101020?? 0 €				
860010201??? 290 €				































	12"	22"	24"	
8537281110?? 0 €				
8510??003609 0 €	-			









	12"	22"	24"	
9662????00?? 0 €	-			
9662??01000? 60 €	-			
9662??010009 130 €	-			
966224010022 130 €	-	-		
966224010007 60 €	-	-		



	12"	22"	24"	
8551??102009 0 €	-			
8555??000009 450 €	-			
8554????0009 295 €	-			

	12"	22"	24"	
8571??1021?? 290 €	-			

--	--

77110000067 140 €			
77110000071 140 €			
77110000055 140 €			
77110000079 165 €			
771 00000155 120 €			
771100000159 120 €			
771100000111 110 €			
771 00000103 110 €			
771100000143 135 €			
771100000135 135 €			
771100000147 165 €			
771100000163 165 €			
771100000179 120 €			
771100000171 120 €			
771100000016 165 €			
771100000015 165 €			
771100000021 140 €			
771100000020 140 €			
771100000019 140 €			
771100000187 175 €			
771100000191 175 €			
771100000183 175 €			
771100000275 165 €			
771100000279 165 €			
771100000195 200 €			
771100000267 200 €			
771100000283 195 €			
771100000235 140 €			
771100000231 140 €			
771100000223 140 €			
771100000259 180 €			

	XXS	XS	S	M	L	LX	
7711000005?? 150 €	-						
7711000005?? 160 €	-						
7711000006?? 190 €							 
7711000006?? 200 €							 
7711000007?? 230 €	-						 

77110000076? 175 €	-						
7711000007?? 110 €	-	-				-	
77110000075? 120 €	-	-				-	

--	--

--	--

000000001104
100 €

EN ISO 14971

P.4

P.5

P.6

P.7

P.8

P.9

P.10

P.12

