



Merci de nous consulter pour connaître les compatibilités entre les fauteuils et les assistances électriques.



11100000100?	5949 €	1.	W5	150kg <i>max 48cm SW</i>
11100000300?	5949 €	2.	W5 S	150kg <i>max 48cm SW</i>
11100000400?	5949 €	3.	W5 K	150kg <i>max 48cm SW</i>
11100000200?	5949 €	4.	W5 D	150kg <i>max 48cm SW</i>
11100000550?	+663,50	5.	W5 XXL	250kg
120000001500	5949 €	6.	Tukan A*	120kg <i>max 45cm SW</i>
120000002000	5949 €	7.	Tukan B*	120kg <i>max 45cm SW</i>
120000003000	5949 €	8.	Tukan C*	120kg <i>max 45cm SW</i>
120000004000	5949 €	9.	Tukan D*	120kg <i>max 45cm SW</i>
14100000150?	5949 €	10.	Dalton	150kg <i>max 48cm SW</i>
141000001800	+663,50	-	Dalton XXL	Std. 160kg HD 250kg
+829999030030	1653 €	11.	HD	250kg

619000001009	0 €		
619000001109	0 €		
619000001209	0 €		
619000001309	0 €		
619000001409	0 €		
619000001509	0 €		
619000002009	0 €		
619000002109	0 €		
619000002509	0 €		
619000002809	0 €		
619000003209	0 €		
619000003309	0 €		
619000003409	0 €		
619000003509	0 €		
619000003709	0 €		
619000003809	0 €		
619000003909	0 €		
619000003009	780 €		
	0 €		
000000001102	0 €		

Fill in and send to Wolturnus - Ausfüllen und an Wolturnus senden - Udfyld og send til Wolturnus

Subject to Technical Modifications and Printing Errors / Technische Änderungen und Druckfehler vorbehalten
Forbehold for tekniske ændringer og trykfejl

© Wolturnus A/S W5/Tukan/Dalton Winter 2026 v16.1

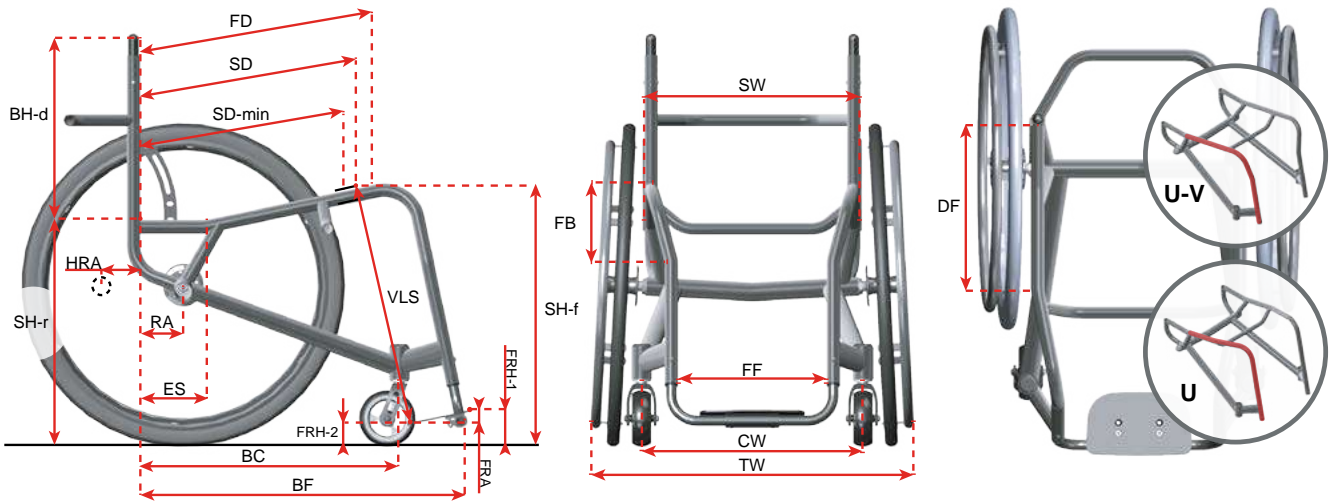

		!		SW: _____ cm
		!		FD: _____ cm std. 44cm
		!		SD: _____ cm std. 41cm
		!		SD_{min}: _____ cm optimized
		!		SH-r: _____ cm std. 42cm
		!		SH-f: _____ cm std. 48cm
		!		BH: _____ cm std. 35cm
		!		C: _____ ° std. 3°
	!			RA: _____ cm std. 8cm
69100001010?	760 €			HRA: _____ cm std. 5cm
61000001009	0 €			
610000??0001	265 €			ES: _____ cm std. 12cm
				BF: _____ cm std. 60cm
			Std. BF-10cm Dalton FD+8cm	BC: _____ cm std. 50cm
				CW: _____ cm FF+15cm
				TW: _____ cm SW+17cm
612000??0009				FB: _____ cm std. 15cm
613000??0009	!			DF: _____ cm std. 30cm
613000000009				
			Std. Ø25: 25,5 – 27,5 – 29,5 – 32,5 – 35,5 cm Std. Ø30: 25,0 – 27,0 – 29,0 – 32,0 – 35,0 cm	FF: _____ cm

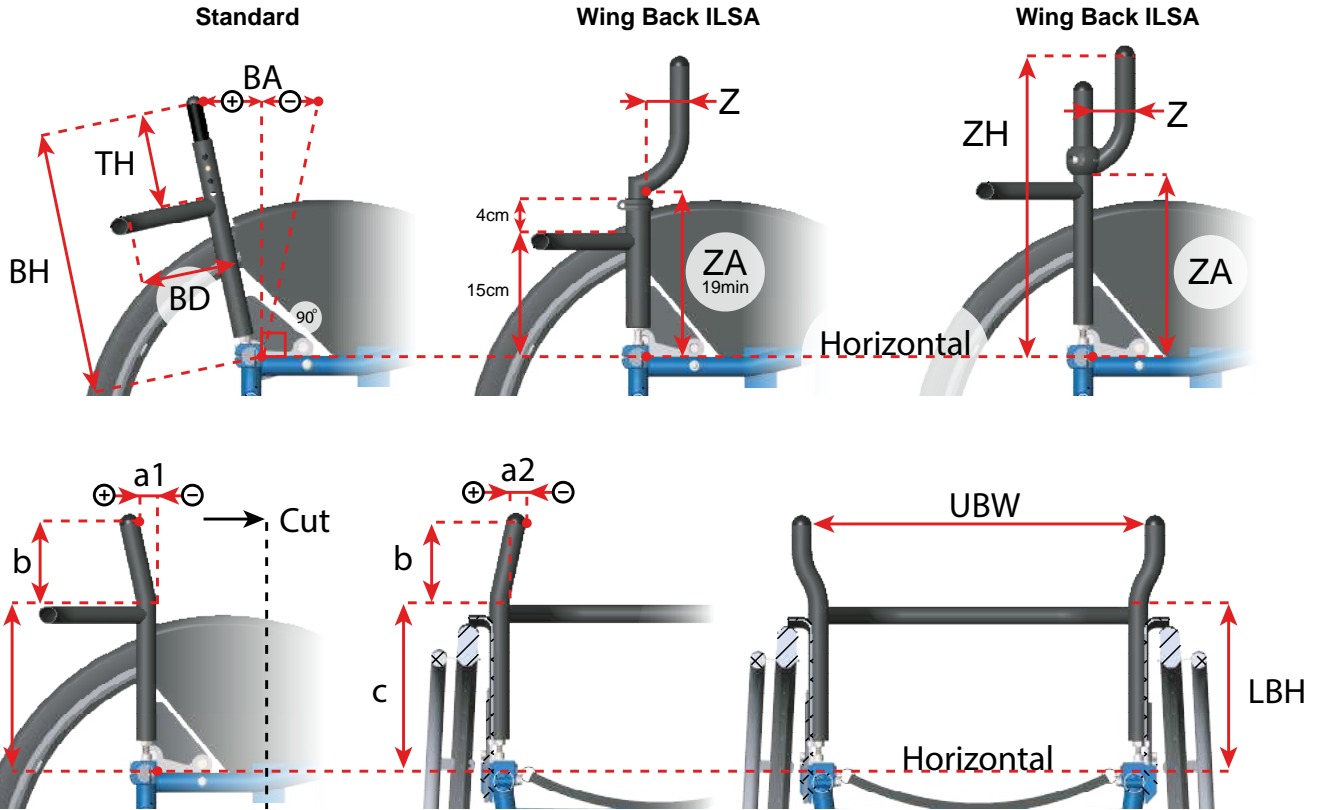

		!		BA: std. 0cm _____ cm
813100050???	0 €		1	
813100051???	0 €		2	
691000010130	70 €		2+	
813100053???	519 €		3	
	0 €			
8122002001??	583 €			Z: 0cm 3cm 5cm 7cm 10cm
8122002001??	754 €			ZH: std. BH _____ cm
				ZA: std. 19cm _____ cm
8122002001??	969 €			Z: std. 5cm _____ cm
	969 €			ZH: std. BH _____ cm
				ZA: std. 19cm _____ cm
825000000038	0 €			BD: std. 12cm _____ cm
825000000048				TH: std. 12cm _____ cm
812200200002	256 €			UBW: SW+/-3cm _____ cm
812200200001				LBH: std. 20cm _____ cm
812200200020	153 €			a1: std. +1cm _____ cm
				a2: std. +0cm _____ cm
				b: std. 15cm _____ cm
				c: std. 20cm _____ cm

Fill in and send to Wolturnus - Ausfüllen und an Wolturnus senden - Udfyld og send til Wolturnus

Subject to Technical Modifications and Printing Errors / Tekniske Ændringer og Druckfejl vorbehalten
Forbehold for tekniske ændringer og trykfejl

© Wolturnus A/S W57Tukan/Dalton Winter 2026 v16.1



				VSL: std. 42cm _____ cm FRA: std. 1cm _____ cm FRH-1: std. 10cm _____ cm FRH-2: std. 9cm _____ cm
				-1,5 ↑ -3,0 ↑ -1,5 ↑ +1,5 ↓ +3,0 ↓ +4,5 ↓ -0 ↓ +0 ↓
8200FF001200	0 €			
8200FF001600	0 €			FRP:1cm FRP:3cm
82??99000000	327 €	1.		FRP:5cm
829999012001	366 €			FRD: std. 12cm _____ cm
8299990000?9	0 €	2.		HE: std. 1cm _____ cm
8299990100?1	284 €	3.		
8299990100?5	235 €	4.		FRD: std. 12cm _____ cm
8299990100?1	475 €	4.		
8299990100?3	547 €	5.		
829999200005	0 €	6.		FRD = 13cm
9512000?000?	0 €	7.		FRD = 14cm
835050001001	1015 €	8.		FRD = 14cm
829999012001	39 €			HE: std. +1cm _____ cm
	0 €			FRP: std. 0cm _____ cm
835099210001	70 €			
691000010001	71 €			RH: std. 23cm _____ cm
825000000003	132 €			FRD: 8-15 cm Max FRH 12cm & Max FRA 2cm
8407100010??	881 €			 Wheelchair Attachment

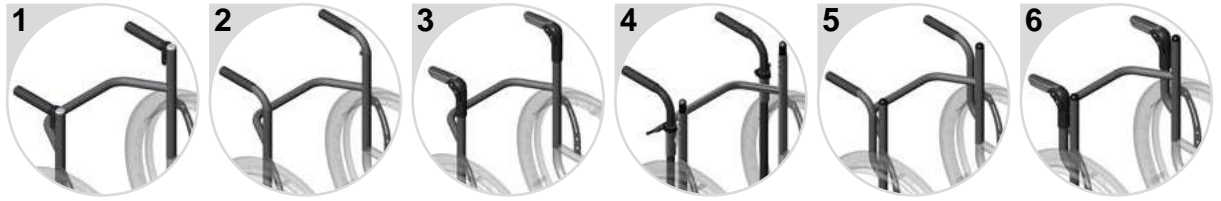

81310005??0?	0 €		-		
81310005?106			1.		
81310005?206	€				
81310005?108	327 €		2.		
81310005?208	383 €				
81310005?107	191 €		3.		
81310005?207	240 €				
81310005??02	574 €		4.		
81310005??03	574 €				
81310005??04	383 €		5.		
81310005??05	601 €		6.		
					PH: std. SH-r + BH _____ cm

	0 €				
	0 €				
	0 €				
8861101013??	678 €		a.		
	339 €				
	339 €				
88611010130?	678 €		b.		
	339 €				
	339 €				
	443 €				
8861101013??	443 €		c.		
	886 €				
					AF: 5-6cm _____ cm AW: 35-36cm _____ cm

691000020020	286 €				
691000020020	286 €				
886210101001	354 €				
886210101001	354 €				

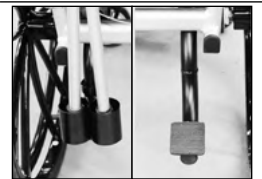

--	--	--	--	--	--

Fill in and send to Wolturnus - Ausfüllen und an Wolturnus senden - Udfyld og send til Wolturnus

Subject to Technical Modifications and Printing Errors / Technische Änderungen und Druckfehler vorbehalten
Forbehold for tekniske ændringer og trykfej

© Wolturnus A/S W57 Tukan/Dalton Winter 2026 v16.1

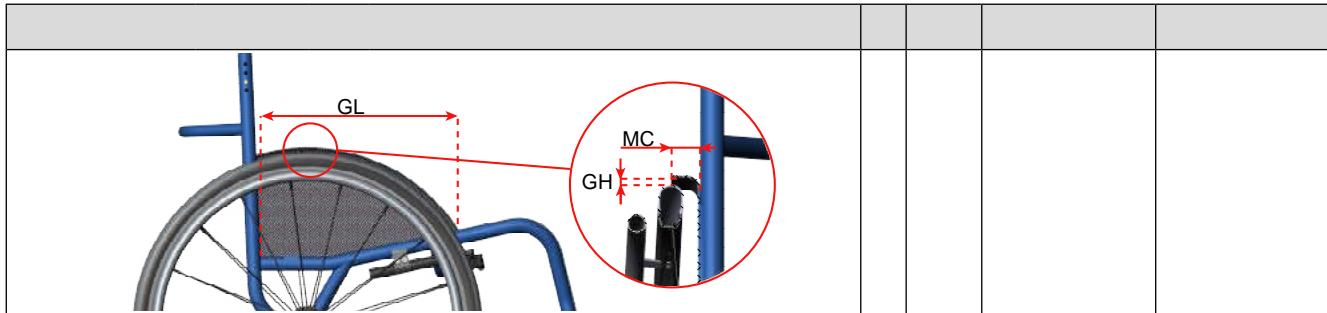

881000600003	0 €			
88100010000?	0 €			
881000?0000?	0 €			
88100040000?	313 €			
8810002000??	741 €			
88100050000?	775 €			
881000500022	775 €			
881000500012	775 €			
881000500032	775 €			
881000500042	775 €			
881000500052	775 €			
881000500062	775 €			
881000500005	775 €			
883124101034	1092 €			
8810003000??	818 €			
881000300022	818 €			
881000300012	818 €			
881000300032	818 €			
881000300042	818 €			
881000300052	818 €			
881000300062	818 €			
881000300005	818 €			
883124101030	1057 €			
-	0 €			

	0 €			
681000010007	0 €			
681000010004	184 €			
883124101014	250 €			
681000010052	77 €			

				GH: std. 1,0cm _____ cm GL: follow tire _____ cm MC: center _____ cm
--	--	--	--	--

767000000010	177 €			SW-s = SW-6mm
767000000013	177 €			SW-s = SW-20mm
767000000014	177 €			SW-s = SW-40mm

--	--	--	--	--

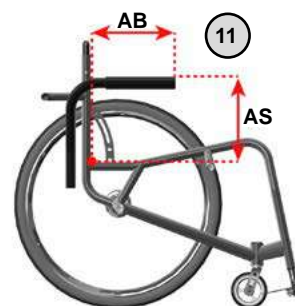
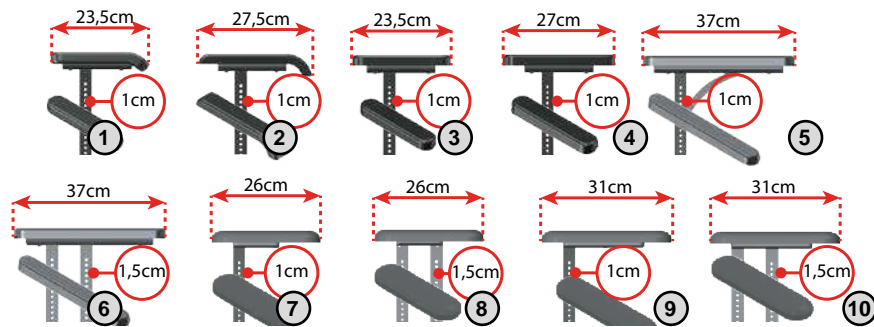

WOLTURNUS

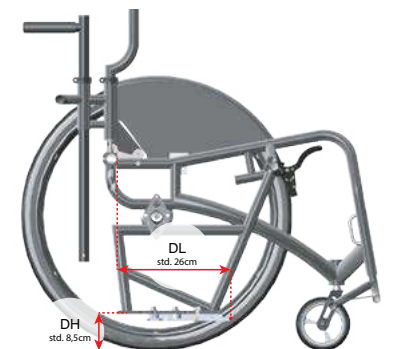

	0 €		-	
88100100003	0 €	1.		AB = 29 cm (Max. 150kg)
88100110003	573 €	2.		AB = 30,5 cm (Max. 150kg)
88100120003	573 €	3.		AB = 27,5 cm (Max. 150kg)
88100130003	573 €	4.		AB = 30 cm (Max. 150kg)
881001?0003	834 €	5.		AB = 41 cm (Max. 150kg)
881001?0003	990 €	6.		AB = 41 cm (Max. 250kg)
881001?0003	886 €	7.		AB = 31 cm (Max. 150kg)
881001?0003	1042 €	8.		AB = 31 cm (Max. 250kg)
881001?0003	886 €	9.		AB = 34,5 cm (Max. 150kg)
881001?0003	1042 €	10.		AB = 34,5 cm (Max. 250kg)
883124101002	578 €	11.		AB: std. 35cm _____ cm AS: std. 26cm _____ cm

	0 €		0.		
885110101001	0 €	1.			
885110101003	0 €	2.			
885110111001	207 €	3.			
885110122002	122 €	+			
885110201009	163 €	4.			
885110200909	207 €	5.			
885110101101	207 €	6.			
885110111101	207 €	7.			
951519204000	188 €	+			
885110201209	235 €	8.			
885110201300	261 €	9.			
840000207242	469 €	10.			
840000207239					
9515?????00??	0 €	x			
691000020001	179 €	y			
-	179 €	z			
	0 €	-			

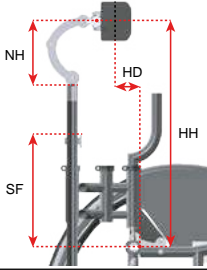

	0 €								NH: _____ cm std. 32cm	
884100013001	250 €								HH: _____ cm std. 32cm	
88410001400?	360 €								HD: _____ cm std. 32cm	
951000080130	97 €	a.								
951000080131	118 €									
951000080141	118 €									
951000080142	118 €	b.								
840000100831	221 €									
840000100832	221 €	c.								
840000100832	221 €									
884100250100	198 €								SF: _____ cm std. 32cm	

825000000001	300 €								
825000000009	417 €								
88700020000?	519 €								
887000200011	2502 €								DH: _____ cm std. 8,5cm DL: _____ cm 23cm

Fill in and send to Wolturnus - Ausfüllen und an Wolturnus senden - Udfyld og send til Wolturnus

	0 €		1.					
710000001110	0 €		2.					
-	0 €		+				+0	+1
-	0 €		+				+0	+1
710000001120	327 €		3.					
710099990010	459 €							
710000002502	0 €		+				+0	+1
-	0 €		+					+2
761000000010	10 €		+				+0	+1
750000000103	+ €		+					+2

710099990001	0 €		1.					
710000001?20	208 €		2.					





710000000000	0 €		1.					
725029351009	0 €		2.					
725029351009	0 €		3.					
-	0 €		4.					

750000009000	275 €		1.					
750000000001	0 €		+					
750000000005	71 €		+					
750000000006	71 €		+					
			!				5cm	7cm
							5cm	7,5cm
75000000000?	71 €							

76000010001	71 €		1.					
76000010015	65 €		2.					
76100000001	169 €		3.					
76100000002	235 €							
771100000751	118 €							
771100000750	118 €		4.					
771100000749	118 €							
771100000747	118 €		5.					



© Wolturnus A/S W57Tukan/Dalton Winter 2026 v16.1

		4"	5"	6"	
860010101401	0 €				
860010101253	0 €				
8600102009?0	186 €				
8600101020??	0 €				
	0 €				
	0 €				
	0 €				
	0 €				
860020000000	54 €				
860010201???	339 €				
	339 €				
	339 €				
	339 €				
	393 €				
	393 €				
				+	
860010202???	339 €				
	339 €				
				+	
	0 €				
	167 €				
	167 €				
	167 €				
955067070012	625 €				
955067070011	625 €				
862400001009	327 €				

		22"	24"	25"	26"	ERTRO
	0 €					
96622?0100??	0 €					(25-489) (25-540) (23-559) (25-590)
96622?01000?	0 €					(25-489) (25-540) (23-559) (25-590)
96622?010009	0 €					(25-489) (25-540) (23-559)
966224010021	154 €					(25-540)
966224010013	72 €					(25-540)
966224011008	72 €					(37-540)
966224010007	72 €					(37-540)

		22"	24"	25"	26"	
	0 €					
85102??01009	0 €					
85102?10100?	0 €					
8510??101002	268 €					
851124201009	491 €					
8537281110??	852 €					
	852 €					
8537281110??	1365 €					
	1365 €					

		22"	24"	25"	26"	
85352?101?09	933 €					
85352?102108	933 €					
85352?101208	933 €					
85352?101508	933 €					
85352?101308	933 €					
85352?101608	990 €					
85352?101408	990 €					
85352?101808	990 €					
85352?101708	990 €					
85352?101009	724 €					
85352?101?09	724 €					
85352?101209	724 €					
85352?101509	724 €					
85352?101309	724 €					
85362?241008	990 €					
85362?181208	990 €					
85362?181508	990 €					
85362?181308	990 €					
85352?181107	993 €					

953001040120	114 €				
--------------	--------------	--	--	--	--

--	--	--	--	--	--

		22"	24"	25"	26"	
	0 €					
85512?10200?	0 €					
85502?103009	186 €					
85552?000009	524/656 €					
8554202?0601	0 €					
8554262?0601	588 €					
8554272?0601	588 €					
8554282?0601	715 €					
8554282?0602	715 €					
8554302?0601	715 €					
8554502?060?	729 €					
8554502?060?	729 €					
			!			
85712?102009	186 €					

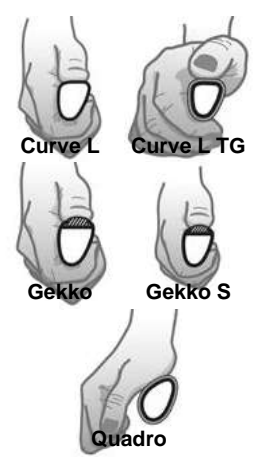

		i	
	0 €		
853727110001	1292 €		
853727110002	1292 €		
853727110004	1292 €		
853727110005	1292 €		
853727110007	1292 €		
951099250460	214 €		
951099250560	214 €		

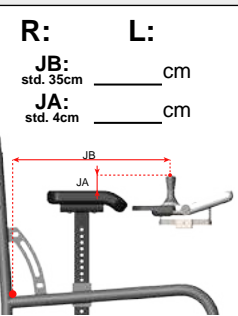

	0 €		
853728120000	239 €		
	239 €		



	0 €		
853728111039	NA €		
853728111062	607 €		
853728111061	607 €		
853728111064	595 €		
853728111063	595 €		
825000000007	120 €		

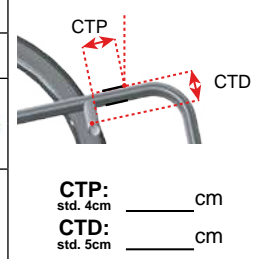

--	--	--

000000001104 110 €		
-----------------------	--	--

EN ISO 14971

--	--

P.4	
-----	--

P.5	
-----	--

P.6	
-----	--

P.7	
-----	--

P.8	
-----	--

P.9	
-----	--

P.10	
------	--

P.11	
------	--

P.12	
------	--

P.13	
------	--

P.14	
------	--

